



# PULZON

Pametni temperaturni regulatorji / Smart temperature controllers

## Temperaturni regulator za eno kontrolno cono tip PULZONbasic

Koda za naročanje: / Art. Nr. : PULZONbasic

- 3-vrstičen zaslon
- Autotuning - samodejno ugaševanje
- Zaklepanje tipkovnice
- Enostavno ravnanje
- 5 pinski konektor



Prednja stran / Front panel

## Temperature controller for one control zone Type PULZONbasic

- 3 digit display
- Adaptive self-optimizing control action, AUTOTUNING
- Keyboard interlocking
- Easy handling
- 5 pin connector plug

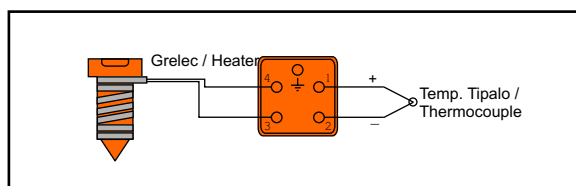

5 polni konektor / 5 pole connector ILME

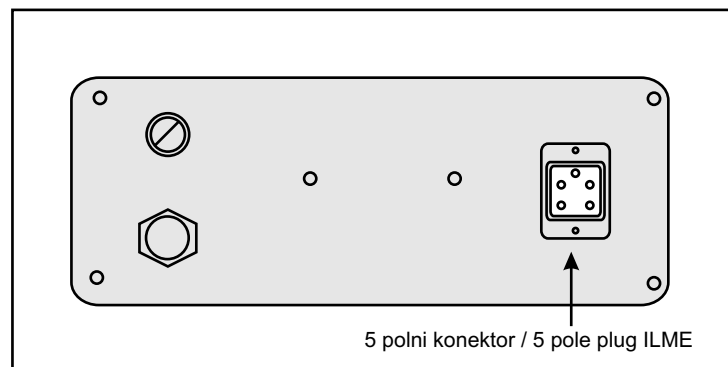

5 polni konektor / 5 pole plug ILME

Zadnja stran / Back panel

## Specifikacija / Specifications:

Temp. Regulator / Temp. Controller:	PIXSY ATR 121B
Rele / Relay:	Brezkontaktni rele SSR 50A / Solid State Relay SSR 50A
Priključna napetost / Main Supply:	230V 50Hz, 1P/N/PE
Priključna moč / Output power:	max 2000W 230V
Temp. Tipalo / Thermocouple:	tip J and L (Fe-CuNi), optional tip K Ni-CrNi
Priključek za grelec in tipalo /Connector for heater and thermocouple:	5 polni konektor / 5 pole plug ILME
Napajalni kabel / Power supply:	3 x 1,5 mm <sup>2</sup> , L - 2000 mm
Varovalka / Fuse:	hitra / fast FF 10 A, 6.3 x 32 mm
Dimenzija / Dimension:	210x80x180 mm (šxvxg) (hxwxd)
Komplet vsebuje / Consist of:	Temp. Regulator, Napajalni kabel, Konektor / Temp. Controller , Connection cable, male / female connector plug

Koda za naročanje / Art. Nr. : PULZONSmart

## Temperaturni regulator za eno kontrolno cono tip PULZONsmart

- dva 4-vrstična zaslona z nastavitveno in dejansko temperaturo
- Autotuning - samodejno ugaševanje
- Soft-start - funkcija mehkega zagona
- Temperaturna in procentualna regulacija
- Delovanje tudi v primeru odpovedi sonde
- Zaklepanje tipkovnice
- Enostavno ravnanje
- 5 pinski konektor
- Opcija preklon med temp. SET1 in SET2



Prednja stran / Front panel

## Temperature controller for one control zone Type PULZONsmart

- two 4-digits displays for set- and actual values
- Smart selfoptimisation, AUTOTUNING
- Soft-start-function
- manual / automatic mode switchable
- Continuous operation of a zone even with a defective thermocouple
- Keyboard interlocking
- Easy handling
- 5 pin connector plug
- Switching between temp. SET1 and SET2, optional



Regulator ATR-243

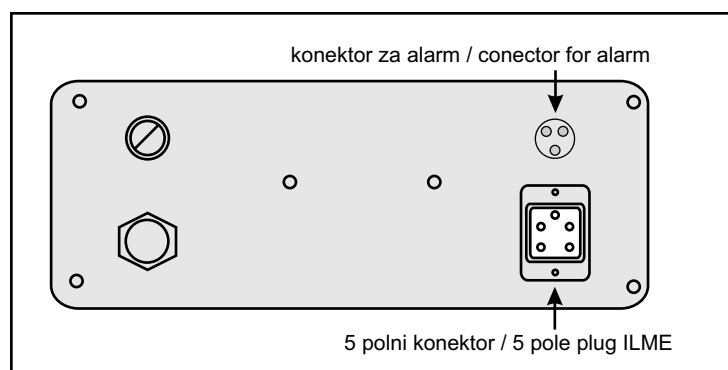

Zadnja stran / Back panel

## Specifikacija / Specifications:

Temp. Regulator / Temp. Controller:	PIXSY ATR 243 - 20 ABC
Rele / Relay:	Brezkontaktni rele SSR 50A / Solid State Relay SSR 50A
Priključna napetost / Main Supply:	230V 50Hz, 1P/N/PE
Priključna moč / Output power:	max 2000W 230V
Temp. Tipalo / Thermocouple:	tip J and L (Fe-CuNi), optional tip K Ni-CrNi
Priključek za grelec in tipalo / Connector for heater and thermocouple:	5 polni konektor / 5 pole plug ILME
Napajalni kabel / Power supply:	3 x 1,5 mm <sup>2</sup> , L - 2000 mm
Varovalka / Fuse:	hitra / fast FF 10 A, 6.3 x 32 mm
Dimenzija / Dimension:	210x80x180 mm (šxvxg) (hxwxd)
Komplet vsebuje / Consist of:	Temp. Regulator, Napajalni kabel, Konektor / Temp. Controller , Connection cable, male / female connector plug



Regulator ATR-243

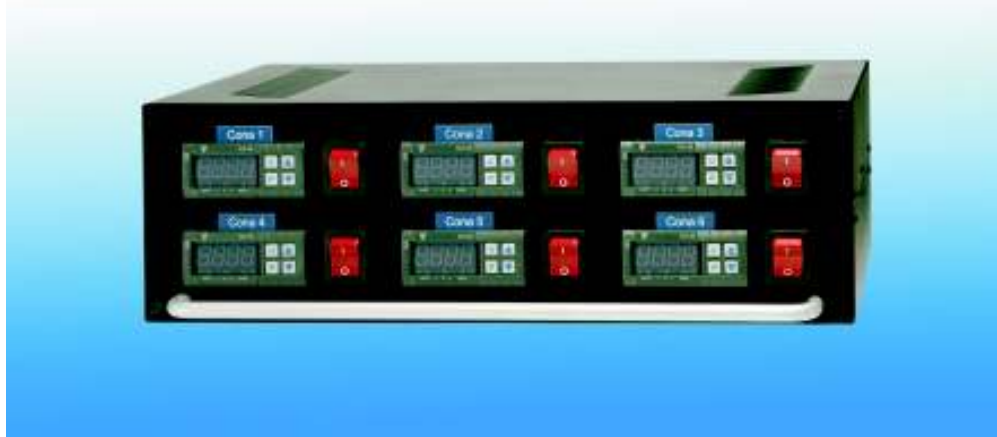

Prednja stran / Front panel

## Temperaturni regulator za 2 - 18 con tip PULZONSmart

- dva 4-vrstična zaslona z nastavitveno in dejansko temperaturo
- Autotuning - samodejno ugaševanje
- Soft-start - funkcija mehkega zagona
- Temperaturna in procentualna regulacija
- Delovanje tudi v primeru odpovedi sonde
- Zaklepanje tipkovnice
- Enostavno ravnanje
- Konektor za priklop
- Opcija preklon med temp. SET1 in SET2

## Temperature controller for 2 - 18 control zones Type PULZONSmart

- two 4-digits displays for set- and actual values
- Smart selfoptimisation, AUTOTUNING
- Soft-start-function
- manual / automatic mode switchable
- Continuous operation of a zone even with a defective thermocouple
- Keyboard interlocking
- Easy handling
- Connector plug
- Switching between temp. SET1 and SET2, optional

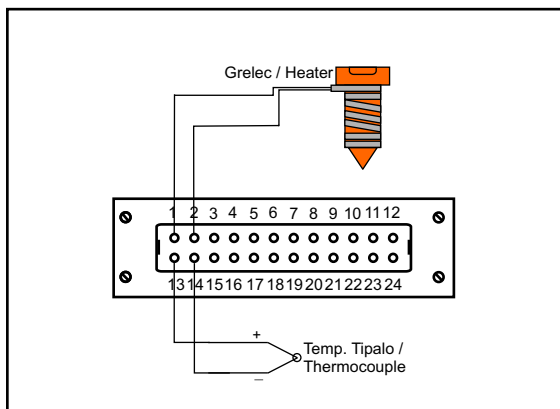



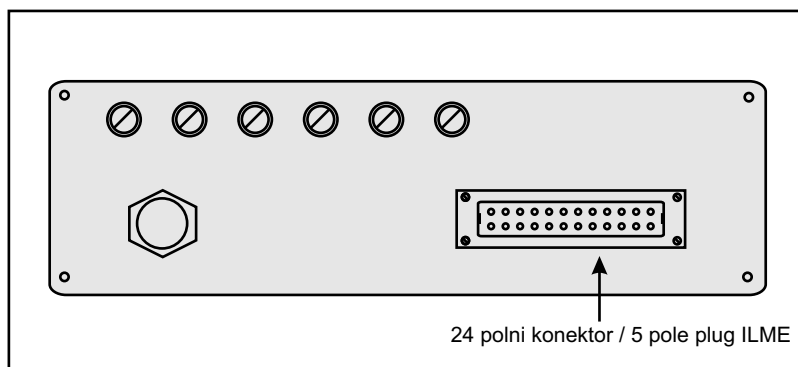





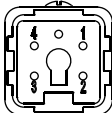

24 polni konektor / 24 pole conector ILME

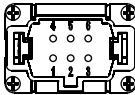

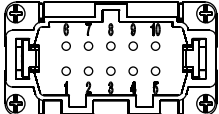
Zadnja stran / Back panel

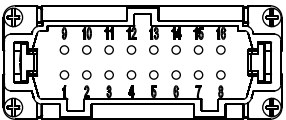
## Pregled priključkov / Connector specifications

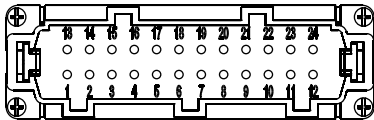
 <p>Ohišje za orodja / Mould connector CK03 I</p>	 <p>Ohišje za kabel /Cabel connector CK03VS</p>	<p><b>1 cona / 1 zone</b></p>  <p>10A230V Vložek / Male &amp; Female insert CKM04/CNF04</p>
 <p>Ohišje za orodja / Mould connector CHI06L</p>	 <p>Ohišje za kabel /Cabel connector CHO06L13</p>	<p><b>1 cona / 1 zone</b></p>  <p>16A230V Vložek / Male &amp; Female insert CNM06/CNF06</p>
 <p>Ohišje za orodja / Mould connector CHI10</p>	 <p>Ohišje za kabel /Cabel connector CHO10</p>	<p><b>2 zoni / 2 zones</b></p>  <p>16A230V Vložek / Male &amp; Female insert CNM10/CNF10</p>
 <p>Ohišje za orodja / Mould connector CHI16</p>	 <p>Ohišje za kabel /Cabel connector CHO16</p>	<p><b>4 zone / 4 zones</b></p>  <p>16A230V Vložek / Male &amp; Female insert CNM16/CNF16</p>
 <p>Ohišje za orodja / Mould connector CHI24</p>	 <p>Ohišje za kabel /Cabel connector CHO24</p>	<p><b>6 con / 6 zones</b></p>  <p>16A230V Vložek / Male &amp; Female insert CNM24/CNF24</p>

## Temperaturni regulator od 1 - 18 con tip PULZONSmart / Temperature controller from 1 to 18 zone type PULZONSmart

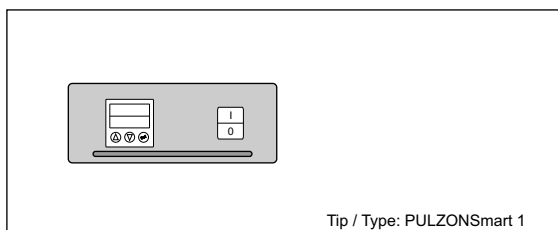

Regulator za 1 cono  
Priključek:  
5-polni konektor  
Priklop: 230V  
Dimenzije: 60x240x180 (vxšxg)

Control unit for 1 control zone  
Connection:  
5-pole plug  
Input connection: 230V  
Dimension: 60x240x180 (hwxwd)

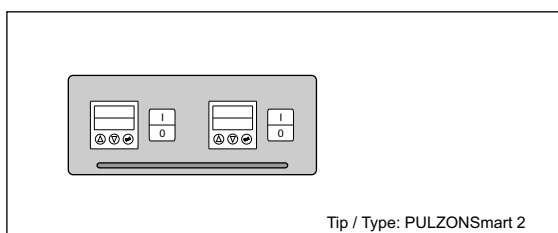

Regulator za 2 cone  
Priključek:  
10-polni konektor  
Priklop: 230V  
Dimenzije: 100x250x200 (vxšxg)

Control unit for 2 control zones  
Connection:  
10-pole plug  
Input connection: 230V  
Dimension: 100x250x200 (hwxwd)

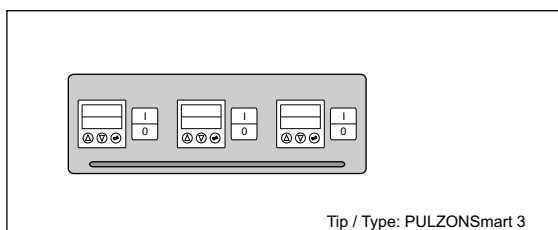

Regulator za 3 cone  
Priključek:  
16-polni konektor  
Priklop: 400V  
Dimenzije: 100x300x250 (vxšxg)

Control unit for 3 control zones  
Connection:  
16-pole plug  
Input connection: 400V  
Dimension: 100x300x250 (hwxwd)

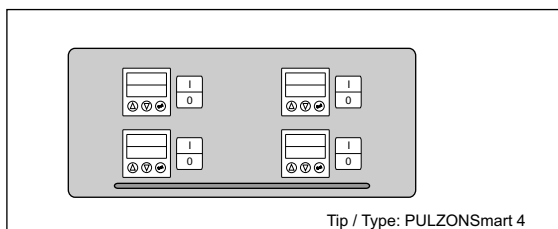

Regulator za 4 cone  
Priključek:  
16-polni konektor  
Priklop: 400V  
Dimenzije: 150x350x250 (vxšxg)

Control unit for 4 control zones  
Connection:  
16-pole plug  
Input connection: 400V  
Dimension: 150x350x250 (hwxwd)

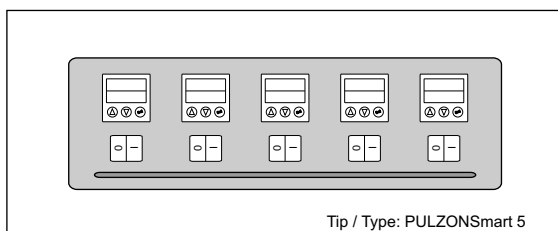

Regulator za 5 con  
Priključek:  
24-polni konektor  
Priklop: 400V  
Dimenzije: 132,5x436x260 (vxšxg)

Control unit for 5 control zones  
Connection:  
24-pole plug  
Input connection: 400V  
Dimension: 132,5x436x260 (hwxwd)

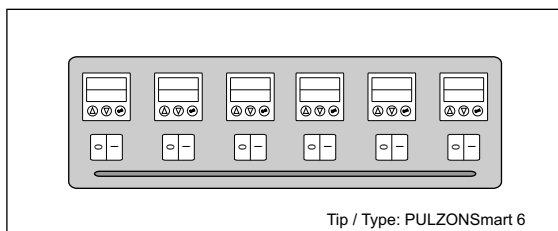

Regulator za 6 con  
Priključek:  
24-polni konektor  
Priklop: 400V  
Dimenzije: 132,5x436x360 (vxšxg)

Control unit for 6 control zones  
Connection:  
24-pole plug  
Input connection: 400V  
Dimension: 132,5x436x360 (hwxwd)

## Temperaturni regulator od 1 - 18 con tip PULZONSmart / Temperature controller from 1 to 18 zone type PULZONSmart

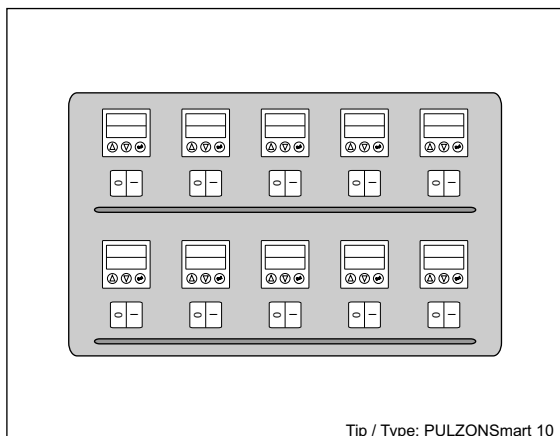

Regulator za 10 con  
Priključek:  
2 x 24-polni konektor  
Priklop: 400V  
Dimenzije: 265x436x360 (vxšxg)

Control unit for 10 control zone  
Connection:  
2 x 24-pole plug  
Input connection: 400V  
Dimension: 265x436x360 (hxwxd)

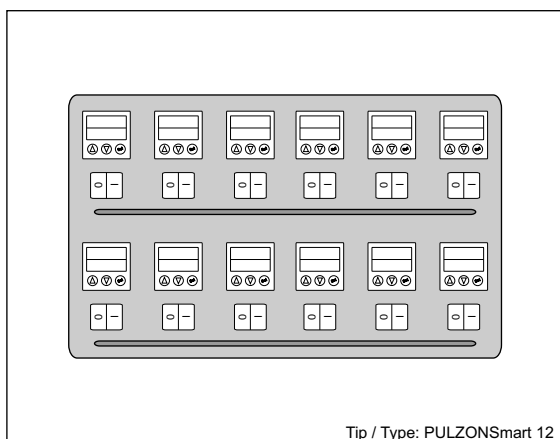

Regulator za 12 con  
Priključek:  
2 x 24-polni konektor  
Priklop: 400V  
Dimenzije: 265x436x360 (vxšxg)

Control unit for 12 control zone  
Connection:  
2 x 24-pole plug  
Input connection: 400V  
Dimension: 265x436x360 (hxwxd)

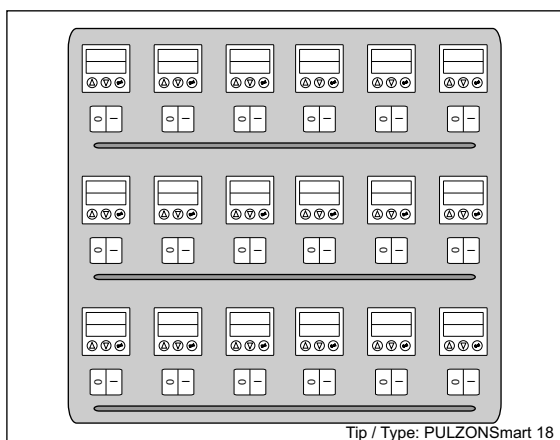

Regulator za 18 con  
Priključek:  
3 x 24-polni konektor  
Priklop: 400V  
Dimenzije: 397,5x436x360 (vxšxg)

Control unit for 18 control zone  
Connection:  
3 x 24-pole plug  
Input connection: 400V  
Dimension: 397,5x436x360 (hxwxd)

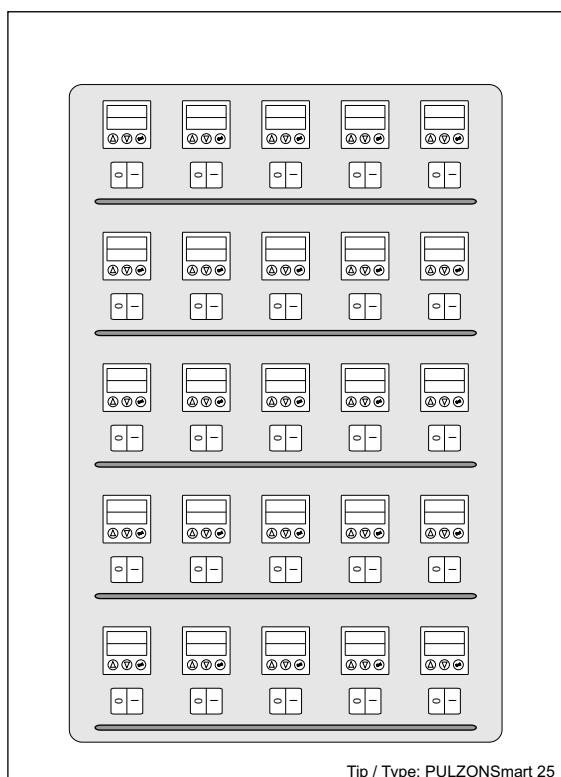

Regulator za 25 con  
Priključek:  
5 x 24-polni konektor  
Priklop: 400V  
Dimenzije: 662,5x436x360 (vxšxg)

Control unit for 25 control zone  
Connection:  
5 x 24-pole plug  
Input connection: 400V  
Dimension: 662,5x436x360 (hwxwd)





**HEATWEAR SINCE 1963**

GRELCI MARAS  
Maras Mladen s.p.  
Jevčeva pot 2  
1351 Brezovica  
SLOVENIJA

T: + 386 1 365 3 518  
F: + 386 1 365 73 72

E: [maras@siol.net](mailto:maras@siol.net)  
W: [www.grelci-maras.si](http://www.grelci-maras.si)